

ROSSLARE

INSTRUCTION MANUAL

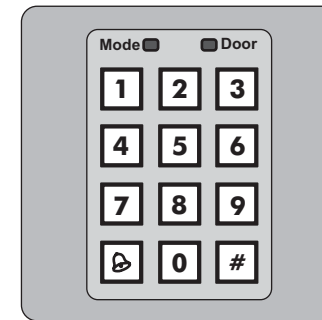

AC-B31

STAND-ALONE
ACCESS CONTROL UNIT

ROSSLARE
www.rosslare.com.hk

9J-IDR-014-A / 0706-0820014-01

InteliDoor 
Smart Access Control

08/01

Contents

INTRODUCTION	3
Technical Specifications	4
Key Features	5
INSTALLATION	6
Mounting the AC-B31 Controller	6
Wiring Diagrams	8
FEATURES AND CONCEPTS	
Normal, Secure, & Master Users	10
Modes Of Operation	11
Changing the Modes of Operation	12
Request To Exit (REX) Button	14
Case and Back Tamper	14
BL-D40 External Sounder	15
PROGRAMMING THE AC-B31	16
Entering Programming Mode	17
Exiting Programming Mode	17
1 Changing the Open Code 1	18
2 Changing the Open Code 2	18
3 Changing the Programming Code	19
4 Changing the Normal / Secure Code	20
5 Changing the Normal / Bypass Code	20
Door Chime Settings	20
6 Setting Fail Safe / Secure Operation	22
Setting Tamper Siren Time	22
Setting the Lock Strike Release Time	22
7 Enrolling Primary and Secondary Codes	23
8 Deleting Primary and Secondary Codes	26
0 Return to Factory Default Settings	28
Replacing a lost Programming Code	29
Replacing a lost Normal / Secure Code	29
APPENDIX	
Glossary	30
TECHNICAL SUPPORT	33

Introduction

The AC-B31 is a keypad access control unit.

The unit accepts up to 500 users and provides entry via the use of PIN codes.

Equipment provided

The following is provided as part of every AC-B31 package:

- AC-B31 Access Control Unit.
- Installation Kit
- Installation and Operating Instructions

Additional Equipment Required

- 1) Electric Lock Strike Mechanism**
Fail Safe (Power to Lock) or Fail Secure (Power to Open)
- 2) Power Supply with Backup Battery**
12 to 16V DC (From a Regulated Power Supply)
- 3) Request To Exit (REX) Button**
Normally Open Type - Switch is closed when pressed.
- 4) BL-D40 External Sounder (Optional)**
Provides Siren, Bell, and Chime functions to AC-B31

Other Rosslare accessories can be found at Rosslare's Web Site:

<http://www.rosslare.com.hk>

Technical Specification

Electrical Characteristics

Operating Voltage Range:
12 to 16V DC From a Regulated Power Supply

Maximum Input Current:
Standby: 20mA Not including attached devices
Max: 60mA Not including attached devices

Relay Outputs:
Lock Strike Relay Electronic, 3.5A
with built in suppressor protection
Auxiliary Relay Form C, 1A

Inputs:
REX N.O., Dry Contact
Auxiliary Input (In / Monitor) N.C., Dry Contact in Monitor Mode
N.O., Dry Contact in Input Mode

LEDs
Two Tri-colored LEDs

Environmental Characteristics

Operating Temperature: -25°F to 145°F (-31°C to 63°C)

Operating Humidity: 0 to 95% (Non-Condensing)

Mechanical Characteristics

Dimensions:
3.62" (92mm) L x 3.62" (92mm) W x 0.94" (24mm) D

Weight:
0.3 lbs (130g)

Key Features

Here are some of the AC-B31's key features:

- Built in Keypad for PIN code entry
- Internal Buzzer
- Comes with security screw and security screw tool
- Two Status / Programming Interface LED's
- Three User Levels
(Normal User, Secure User, Master User)
- Three Modes of Operation
(Normal Mode, Bypass Mode, Secure Mode)
- "Code Search" feature makes maintaining user codes easier.
- Input for Request to Exit (REX) button.
- Lock Strike Electronic Relay with built-in suppressor protection.
- Comes with mounting template for easier installation.
- Built in Case and Back Tamper
- Bell, Chime, Siren, and Strobe features available with BL-D40.
- Bell, Chime, Siren, Battery Backup, Tamper Output (Open Collector 20mA) features available with PS-X41 (Output Power 1.2A) and PS-X42 (Output Power 1.8A).
- Programmable Siren Time
- Programmable Lock Strike Release Time
- Comes with Suppression Diode (1N4004)

Installation

Mounting the AC-B31 Controller

- 1) Before starting, select the location to mount the AC-B31 controller. This location should be at shoulder height and on the same side as the door handle.
- 2) The AC-B31 is designed to be easily mounted to a US Gang Box. Remove the Bezel Screw. (Use the diagram below to help you locate the Bezel Screw)

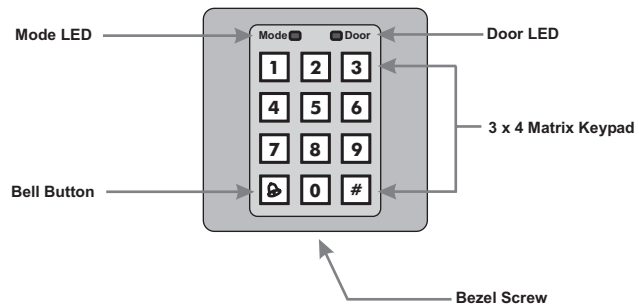

- 3) Screw the controller onto a US Gang Box through the two Mounting Holes provided. (See diagram on the next page to help you locate the US Gang Box mounting holes)

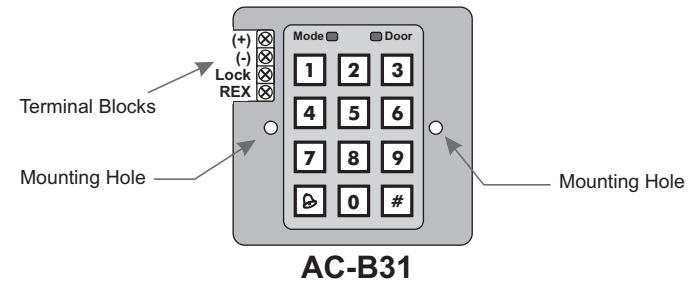

- 4) Pass the wires through the exit/entry holes and attach them to the controller's terminal blocks as shown in the wiring diagrams. (Wiring diagrams for common installations can be found on pages 10 to 12).
- 5) Replace the controller's bezel and replace the factory default screw with the security screw that is provided in the Installation Kit. A security screw tool is also provided in the Installation Kit.

Wiring the AC-B31 Controller

A few of the typical wiring diagrams are shown on the next three pages; for other wiring diagram examples refer to the support section of the Rosslare Web Site.

<http://www.rosslare.com.hk/support>

Wiring Diagrams

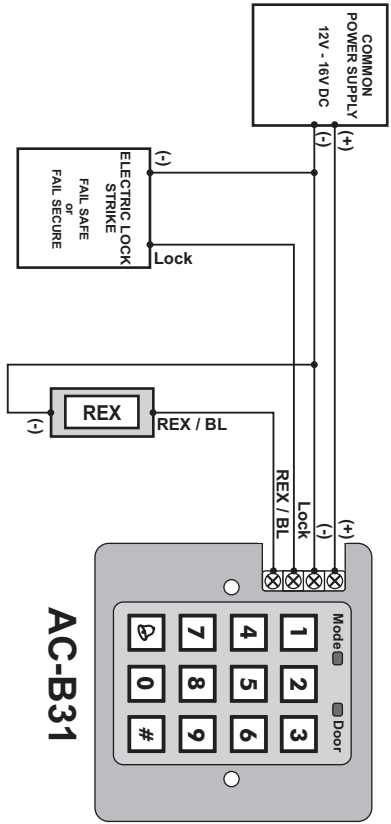

Wiring the Lock Strike Relay and REX

Wiring the BL-D40 External Sounder

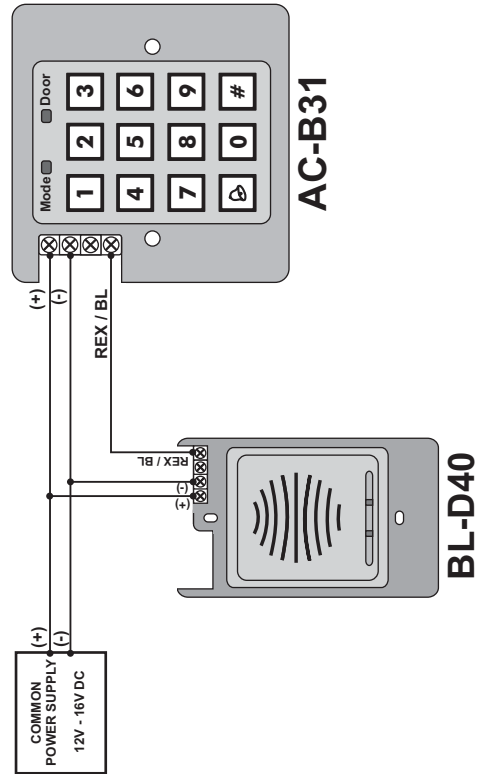

Normal, Secure, & Master Users

The AC-B31 accepts up to 500 users and provides entry via the use of PIN codes. Each user is provided with two code memory slots, Memory Slot 1 (Primary Code) and Memory Slot 2 (Secondary Code).

The way in which the two memory slots are programmed determines a users access level and also determines the way in which the AC-B31 grants access in its three Modes of Operation.

There are three user levels:

Normal User

A Normal User only has a Primary Code and is only granted access when the AC-B31 is in Normal or Bypass Mode.

Secure User

A Secure User must have a Primary and Secondary Code programmed, the two codes must not be the same. The Secure User can gain access when the AC-B31 is in any of its three Modes of Operation. In Normal Mode the Secure User must use their Primary Code to gain entry. In Secure Mode the Secure User must present both their Primary and Secondary Codes in order to gain entry.

Master User

A Master User must have both Primary and Secondary Codes programmed with the same PIN code. The Master User can gain access during any Mode of Operation by presenting their PIN code to the controller. (The Master User is convenient but is less secure than a Secure User).

Modes of Operation

The AC-B31 has 3 Modes of Operation:

1) Normal Mode.

- Mode LED is green

Mode   Door
GREEN

Normal Mode is the default mode. In Normal Mode the door is locked until a Primary Code is presented to the controller. Special codes such as "Open Code 1" and "Open Code 2" are active in Normal mode. (See Page 18 for more information on Open Code 1 & Open Code 2).

2) Bypass Mode.

- Mode LED is orange

Mode   Door
ORANGE

In Bypass Mode, access to the premises is dependent on whether the controller's Lock Strike Relay is programmed for Fail Safe Operation or Fail Secure Operation.

When the Lock Strike Relay is programmed for Fail Secure Operation, the door is locked until the Door Bell Button is pressed.

When the Lock Strike Relay is programmed for Fail Safe Operation, the door is constantly unlocked.

3) Secure Mode.

- Mode LED is red

Mode   Door
RED

Only Secure and Master Users can access the premises during the Secured Mode.

A Secure User must enter their Primary and Secondary Codes to gain entry. After entering their Primary Code the Door LED will flash green for 10 seconds, during which the Secondary Code must be entered.

A Master User only needs to present their PIN code once to gain entry.

Changing the Modes of Operation

Changing from Normal Mode to Secure Mode:

The default factory setting for the Normal / Secure Code is 3838

- 1) Enter the 4-digit Normal / Secure Code
• Mode LED will flash red
- 2) Press the "#" key to confirm the Mode change.
• Mode LED is red



Changing from Secure Mode to Normal Mode:

The default factory setting for the Normal / Secure Code 3838

- 1) Enter the 4-digit Normal / Secure Code.
• Mode LED will flash green.
- 2) Press the "#" key to confirm the Mode change.
• Mode LED will turn green.



Changing from Normal Mode to Bypass Mode:

See Page 20 to create / modify the Normal / Bypass Code

- 1) Enter the 4-digit Normal / Bypass Code.
• Mode LED will flash orange
- 2) Press the "#" key to confirm the Mode change.
• Mode LED will turn orange



Changing from Bypass Mode to Normal Mode:

See Page 20 to create/modify the Normal / Bypass Code

- 1) Enter the 4-digit Normal / Bypass Code.
• Mode LED will flash green
- 2) Press the "#" key to confirm the Mode change.
• Mode LED will turn green



Request to Exit (REX) Button

The REX button must be located inside the premises to be secured and is used to open the door without the use of a proximity card or PIN code, it is usually located in a convenient location, e.g. Inside the door or at a receptionist's desk. The function of the REX button depends on whether the Lock Strike Relay is programmed for Fail Safe Operation or Fail Secure Operation. The door chime in the BL-D40 does not sound when the REX button is used to open the door.

- 1) Fail Secure Operation: From the moment the REX button is pressed, the door will be unlocked until the "Lock Strike Release Time" has passed. After this time, the door will be locked even if the REX button has not been released.
- 2) Fail Safe Operation: From the moment the REX button is pressed, the door will be unlocked until the REX button is released, plus the "Lock Strike Release Time". In this case the "Lock Strike Relay" only begins its count down once the REX button has been released.

Case and Back Tamper

If the case of the controller is opened or the controller is removed from the wall, a tamper event is triggered and a coded tamper signal is sent to a BL-D40, PS-X41 Series or PS-X42 Series Power Supply, or other compatible device.

If the BL-D40 External Sounder, PS-X41 Series or PS-X42 Series Power Supplies receive a Tamper Event Signal, they will activate a Siren and if available a Strobe Light. The Siren time can be easily programmed in the AC-B31 from 0 to 9 minutes.

Clearing a tamper event is done by entering a valid User or Open Code that will open the Lock Strike Output in the current Mode of Operation. For example, while in Secure Mode, using the Open Code to clear tamper event will not work because the Open Code does not work in Secure Mode. However, applying a Master Code or Secure Code will clear the tamper event in Secure Mode.

BL-D40 External Sounder

The BL-D40 External Sounder is compatible with the AC-X31, AC-X32, AC-X41, and AC-X42 series Standalone Controllers (For a more up-to-date list of compatible products check the Rosslare Web Site at www.rosslare.com.hk). It is designed to operate indoors and installed within the premises to be secured. The Sounder can be powered by 16V AC or 12 to 24V DC power supply.

The BL-D40 is capable of emitting four different types of alerts both audible and visual; Bell, Door Chime, Siren, and Strobe Light.

- 1) The Bell always sounds when the controller's doorbell button is pressed.
- 2) The Door Chime can be programmed to sound whenever the controller unlocks the door (the Door Chime does not sound when the REX button is used to open the door).
- 3) The Siren can be programmed to sound when the case of the controller is opened or when the controller is removed from the wall. The controller can also program the length of the Siren in the BL-D40.

The Controller communicates with the BL-D40 using a coded proprietary Rosslare communications protocol. This provides a more secure link between the Controller and the BL-D40. If the BL-D40 receives any unrecognized codes on its communication line or communication between the controller and the BL-D40 are severed, the Strobe will flash repeatedly until the communication problem has been resolved.

Programming the AC-B31

Programming the AC-B31 is done solely via the unit's keypad driven Programming Menu System. To reach the Programming Menu System the AC-B31 must first be placed into Programming Mode. See "Entering Programming Mode" on Page 17 for more information.

During the AC-B31's manufacturing process certain codes and settings are pre-programmed. These settings are called the "Default Factory Settings".

The table below shows the names of all the AC-B31 Menus. It also shows of all the AY-B31's default factory codes and settings.

Programming Menu

Factory Settings	Menu Description	Menu Number
2580	Change Open Code 1	1
0852	Change Open Code 2	2
1234	Change Program Code	3
3838	Change Normal / Secure Code	4
N/A	Change Normal / Bypass Code	5
0004	Change Door Release Time	6
	Enroll PIN Code.	7
	Delete PIN Code	8
	Return to Default Factory Setting	0

You will find a complete description and instructions for each of the above menu items on the following pages.

Entering Programming Mode

- 1) Press the "#" key for 2 seconds. Mode Door
• Mode LED will turn off RED
• Door LED will turn red

- 2) Enter your 4-digit Programming Code. 1 2 3 4

If the Programming Code is valid the door LED will turn green and the AC-B31 will be in Programming Mode. Mode Door
GREEN

- Note:** - The AC-B31 must be in Normal Mode to enter the Programming Mode.
 - The factory default Programming Code is 1234
 - If a Programming Code is not entered within 5 seconds, the AC-B31 will return to Normal Mode.

Exiting Programming Mode

- 1) To exit the Programming Mode at any time:

Press the "#" key for 2 seconds. Mode Door
• You will hear 3 beeps. GREEN
• The Door LED will be off
• The Mode LED will turn green







This indicates that the AC-B31 has returned to Normal Mode.

- 2) Wrong entries may reset the controller back to Normal Mode.
 3) While in Programming Mode if no key is pressed for 1 minute the AC-B31 will exit programming mode and return to Normal Mode.
 4) A short press on "#" key may also return the system to Normal Mode in certain Programming Modes.

Changing the Open Code 1

The Open Code 1 is mainly used as a method to quickly test the Lock Strike Relay during installation.

The Default Factory Setting for the Open Code 1 is 2580. When the first user is added to the controller, the default Open Code will automatically be deleted, ready for a new Open Code 1 to be re-entered.







- 1) Enter Programming Mode
Mode  Door 
GREEN
- 2) Press "1" to enter **Menu 1**
• The Mode LED will turn red
Mode  Door 
RED GREEN
- 3) Enter the new 4-digit code you wish to set as Open Code 1.

- 4) System returns to Normal Mode
• The Door LED will turn off
• The Mode LED will turn green
Mode  Door 
GREEN

Note: - Open Code 1 does not function in Secure Mode.
- Wrong entries will return the controller to Normal Mode.
- Code 0000 will erase and deactivate the Open Code.

Changing the Open Code 2







The Open Code 2 is mainly used as a method to quickly test the Lock Strike Relay during installation.

The Default Factory Setting for the Open Code 2 is 0852. When the first user is added to the controller, the default Open Code will automatically be deleted, ready for a new Open Code 2 to be re-entered.

- 1) Enter Programming Mode
Mode  Door 
GREEN
- 2) Press "2" to enter **Menu 2**
• The Mode LED will turn red
Mode  Door 
ORANGE GREEN
- 3) Enter the new 4-digit code you wish to set as Open Code 2.

- 4) System returns to Normal Mode
• You will hear three beeps
• The Door LED will turn off
• The Mode LED will turn green
Mode  Door 
GREEN

Note: - Open Code 2 does not function in Secure Mode.
- Wrong entries will return the controller to Normal Mode.
- Code 0000 will erase and deactivate the Open Code.

Changing the Programming Code

- 1) Enter Programming Mode
Mode  Door 
GREEN
- 2) Press "3" to enter **Menu 3**
• The Mode LED will turn green.
Mode  Door 
GREEN GREEN
- 3) Enter the new 4-digit code you wish to set as Programming Code

- 4) System returns to Normal Mode
• You will hear three beeps
• The Door LED will turn off
• The Mode LED will turn green
Mode  Door 
GREEN

Note: - Programming Code can not be erased, i.e. the code 0000 is not valid and will not erase the Programming Code.

Changing the Normal / Secure Code

- 1) Enter Programming Mode Mode Door
GREEN
- 2) Press "4" to enter **Menu 4** Mode Door
RED GREEN
 - The Mode LED will flash red
- 3) Enter the new 4-digit code you wish to set as Normal / Secure Code [?] [?] [?] [?]
- 4) System returns to Normal Mode Mode Door
GREEN
 - You will hear three beeps
 - The Door LED will turn off
 - The Mode LED will turn green

Note: - When the Auxiliary Mode is 1, 2, 3, or 4 the Auxiliary Input takes priority over the Normal / Secure Code.

Changing the Normal / Bypass Code and Door Chime Settings

The Normal / Bypass Code is also used to turn the Door Chime off and on.

- 1) Enter Programming Mode Mode Door
GREEN
- 2) Press "5" to enter **Menu 5** Mode Door
ORANGE GREEN
 - The Mode LED will flash orange.
- 3) Below is a list of the four different ways that the Normal / Bypass Code and Door Chime can be programmed.
 - a) Disable Bypass Mode - Disable Door Chime
 - b) Disable Bypass Mode - Enable Door Chime
 - c) Enable Bypass Mode - Disable Door Chime
 - d) Enable Bypass Mode - Enable Door Chime

a) Disable Bypass Code - Disable Door Chime

Enter the 4-digit code 0000 [0] [0] [0] [0]

b) Disable Bypass Code - Enable Door Chime

Enter the 4-digit code 0001 [0] [0] [0] [1]

c) Enable Bypass Code - Disable Door Chime

Enter any 4-digit code ending with 0 [?] [?] [?] [0]

d) Enable Bypass Code - Enable Door Chime

Enter any 4-digit code not ending with 0 [?] [?] [?] [X]

- 4) System returns to Normal Mode Mode Door
GREEN
 - You will hear three beeps
 - The Door LED will turn off
 - The Mode LED will turn green

Note: - The Door is only generated when the Lock Strike Relay is activated due to a valid code entry.

Setting Fail Safe/Secure Operation Setting Tamper Siren Time Setting the Lock Strike Release Time

- 1) Enter Programming Mode

Mode Door
 GREEN GREEN

- 2) Press "6" to enter **Menu 6**
 - The Mode LED will flash green

Mode Door
 GREEN GREEN

- 3) Construct the 4-digit code using the instructions below:

First Digit
For Fail Secure Operation the first digit should be "0"
For Fail Safe Operation the first digit should be "1"

Second Digit
Tamper Siren Time, enter any number from 1 to 9 minutes.

Third and Fourth Digit
Enter the number of seconds from (1 to 99 seconds) that you want the Lock Strike to be released.

- For example 0 5 1 2 means Fail Secure Operation, with a 5 minute Tamper Siren Time, and a 12 second Lock Strike release time.

- 4) System returns to Normal Mode

Mode Door
 GREEN

 - You will hear three beeps
 - The Door LED will turn off.
 - The Mode LED will turn green

Enrolling Primary & Secondary Codes

Primary Codes

- Primary Codes can only be enrolled to an empty User Slot, i.e a slot where there is no existing Primary Code.
- Primary Codes must be unique, i.e. one users Primary Code may not be the same as another users Primary Code.
- Primary Codes cannot be the same as any system codes, such as the Normal / Secure Code or Open Code.
- Users who hold a Primary Code can gain entry only during Normal Mode.

Secondary Codes

- Secondary Codes can only be enrolled to User Slot that already has a Primary Code enrolled but no Secondary Code.
- Secondary Codes do not have to be unique, i.e. multiple users can all hold the same Secondary Code.
- Secondary Codes cannot be the same as any system codes, such as the Normal / Secure Code or Open Code.
- Users who hold Secondary Codes can gain entry in any Mode of Operation.











Enrolling Primary and Secondary Codes

There are two methods to enroll Primary and Secondary codes, the Standard Method and the Code Search Method.

- A. The Standard Method is mainly used when the User Slot number for the user you wish to program is known. You can program both Primary and Secondary Codes using the Standard method. (See Enrolling Users with the Standard Method on Page 24)

- B. The Code Search Method is mainly used when enrolling a users Secondary Code and the User Slot Code is unknown. The Code Search method only works if a users Primary Code is already enrolled but the Secondary Code is not. (See Enrolling Users with the Code Search Method on Page 25)











Enrolling Primary and Secondary Codes using the Standard Method

- 1) Enter Programming Mode **Mode**   **Door**
GREEN
- 2) Press "7" to enter **Menu 7** **Mode**   **Door**
• The Door LED will turn orange ORANGE
- 3) Enter the 3-digit User Slot number   
between 001 to 500 that you wish to
enroll a Primary or Secondary code to.
For example, the User Slot 003 represents User #3.
- 4) a. If the selected slot has no **Mode**   **Door**
Primary Code, the Mode LED GREEN GREEN
will flash green, indicating that
the controller is ready to accept a Primary Code.
- b. If the selected slot already has **Mode**   **Door**
a Primary Code but no RED GREEN
Secondary Code, the Mode LED
will flash red, indicating that the controller is ready to
accept a Secondary Code.
- c. If the selected slot already has a Primary and Secondary
Code, you will hear a long beep and the controller will return
to Normal Mode.
- 5) Enter the 4-digit PIN that you want to assign as the Primary or
Secondary Code for this slot number.

If the PIN that is entered is valid the Mode LED will stop flashing and then the controller is ready for you to enter the next 3-digit slot number (refer to step 3) that you want to assign a code to, or press the "*" key to move to the next slot number (refer to step 4). If you do not wish to continue enrolling codes, press the "*" key for 2 seconds and the controller will return to Normal Mode.

Enrolling Secondary Codes using the Code Search Method

The Code Search feature enables you to quickly enroll a Secondary Code to a user who already has a Primary Code.

- 1) Enter Programming Mode **Mode**   **Door**
GREEN
 - 2) Press "7" to enter **Menu 7** **Mode**   **Door**
• The Door LED will turn orange ORANGE
 - 3) Enter the 3-digit User Slot number 000   
• The Door LED will flash orange **Mode**   **Door**
ORANGE
- The controller is now waiting for the Primary Code of the User you want to add a Secondary Code to.
- 4) Enter the 4-digit PIN Code of the Primary Code belonging to the user you want to add a Secondary Code to.
• The Mode LED will flash red **Mode**   **Door**
RED ORANGE
- If the Primary Code entered is not valid, you will hear a long beep and the AC-B31 will continue to wait for a valid Primary Code.
- 5) Enter the 4-digit PIN Code to be used as the Secondary Code.

If the Secondary Code is valid the controller will beep three times and return to Normal Mode.

If the Secondary Code is invalid the controller will make a long beep and then the AC-B31 will continue to wait for a valid Secondary code to be entered.



Deleting Primary & Secondary Codes

There are two methods to delete Primary and Secondary codes, the Standard Method and the Code Search Method.



When deleting a User Slot, both the Primary Code and the Secondary code are erased.

Deleting Primary and Secondary Codes using the Standard Method

- 1) Enter Programming Mode

Mode			Door
		GREEN	



- 2) Press "8" to enter **Menu 8**
 - The Mode LED will turn red

Mode			Door
	RED	ORANGE	

- 3) Enter the 3-digit User Slot codes you wish to delete.

?	?	?
---	---	---

 - The Mode LED will flash red indicating the controller is waiting for the Programming Code to confirm the deletion.

Mode			Door
	RED	ORANGE	

If the User Slot is empty you will hear a long beep and the AC-B31 will return to Normal Mode

- 4) Enter your Programming Code to confirm the deletion.

?	?	?	?
---	---	---	---



If the Programming Code is valid, you will hear three beeps and the AC-B31 will return to Normal Mode.

If the Programming Code is invalid, you will hear a long beep and the AC-B31 will return to Normal Mode.



Note: - It is recommended that a record be kept of added and deleted users so that it will be easier to keep track of which user slots are empty and which user slots are not.

Deleting Primary and Secondary Codes using the Code Search Method

- 1) Enter Programming Mode

Mode			Door
		GREEN	



- 2) Press "8" to enter **Menu 8**
 - The Mode LED will turn red

Mode			Door
	RED	ORANGE	

- 3) Enter the 3-digit User Slot 000

0	0	0
---	---	---

 - The Door LED will flash orange



Mode			Door
	RED	ORANGE	

The controller is now waiting for the Primary Code of the User you want to delete.

- 4) Enter the 4-digit PIN Code of the Primary Code belonging to the User you want to delete.

?	?	?	?
---	---	---	---

 - The Mode LED will flash red

Mode			Door
	RED	ORANGE	

If the Programming Code is valid, you will hear three beeps and the AC-B31 will return to Normal Mode.

If the Programming Code is invalid, you will hear a long beep and the AC-B31 will return to Normal Mode.

Note: - It is recommended that a record be kept of added and deleted users so that it will be easier to keep track of which user slots are empty and which user slots are not.

Return To Factory Default Settings

Warning:

You must be very careful before using this command! Doing so will erase the entire memory which includes all User and Special Codes, and return all codes to their factory default settings.

1) Enter Programming Mode



2) Press "0" to enter **Menu 0**

- The Mode LED will flash red
- The Door LED will flash red



3) Enter your 4-digit Programming Code.



- If the Programming Code is valid, all memory will be erased, you will hear three beeps and the controller will return to Normal Mode
- If the Programming Code is invalid you will hear a long beep and the controller will return to Normal Mode without erasing the memory of the controller.

Replacing a lost Programming Code

Note: The AC-B31 must be in Normal Mode otherwise this will not work. Make sure that the Mode LED is green before proceeding.

- 1) Remove power from the AC-B31
- 2) Press the REX button
- 3) Apply power to the unit with REX button pressed
- 4) Release the REX button
- 5) You now have 15 seconds to program a new Programming Code into the unit using the initial default code 1234, before the controller reverts to the existing code.

Replacing a lost Normal / Secure Code

Note: The AC-B31 must be in Secure Mode otherwise this will not work. Make sure that the Mode LED is red before proceeding.

- 1) Remove power from the AC-B31
- 2) Press the REX Button
- 3) Apply power to the unit with REX button pressed.
- 4) Release the REX Button
- 5) You now have 15 seconds to program a new Normal / Secure code into the unit using the initial default code 3838, before the controller reverts to the existing code.

Glossary

A

Access Control: Primarily refers to a device or set of devices controlling the entry of people traveling through a door or set of doors.

Amplitude Shift Keying (ASK): The type of data communications between the Proximity Card and the Proximity Reader.

ASK: An abbreviation of "Amplitude Shift Keying".

B

Back Tamper: The electronic tamper signal advising the controller that the controller has been removed from the wall.

Bypass Code: The four digit code used to change the Mode of Operation of the AC-B31 from Normal to Bypass Mode or vice versa.

Bypass Mode: A Mode of Operation where door access is not restricted to valid users. In this mode the door may be released by anyone pressing the bell button.

C

Cards: See Proximity Cards

Case Tamper: The electronic tamper signal advising the controller that the case has been opened.

D

Default Factory Setting: The settings that the controller is preprogrammed with when the controller is manufactured.

Direct Shunt Delay: The delay time (user programmed) used in Direct Shunt (See Direct Shunt).

Door Bell: The alert sound activated when the door bell button on the AC-

B31 is pressed. (Requires the BL-D40 External Sounder)

Door Chime: The alert sound activated when the lock strike unlocks the door after a valid code has been presented. (Requires the BL-D40 External Sounder)

F

Fail Safe: The system setting in which a total power loss leaves the connected door unlocked.

Fail Secure: The system setting in which a total power loss leaves the connected door locked.

L

Lock Strike: Term used for the electronic or electromagnetic door lock used for locking or unlocking the door.

Lock Strike Release Time: The amount of time (user programmed) that the Lock Strike remains unlocked when a valid code is entered.

M

Master User: A user which has a Primary and Secondary Code which are the same, and can gain access in any Mode of Operation.

Mode of Operation: The state of operation of the controller. There are three "Modes": Normal Mode, Bypass Mode, and Secure Mode.

N

Normal Mode: The system setting (Mode of Operation) in which all valid users have access upon presenting a valid Proximity Card or PIN Code (Primary Code).

Normal / Bypass Code: The four digit code used to change the controllers Mode of Operation from Normal to Bypass Mode or vice versa.

Normal / Secure Code: The four digit code used to change the controllers Mode of Operation from Normal to Secure Mode or vice versa.

Normal User: A user who only has a Primary Code and can only gain access in Normal Mode.

Normally Closed: A relay output from the controller that is activated (closed circuit) under normal conditions.

Normally Open: A relay output from the controller that is de-activated (open circuit) under normal conditions.

O

Open Code 1: The four digit code used to activate the Lock Strike Relay for testing purposes during installation.

Open Code 2: The four digit code used to activate the Lock Strike Relay for testing purposes during installation.

P

Primary Code: The unique code issued to enable access in Normal Mode. Users with only primary codes are Normal Users.

Programming Code: The four digit code required when entering programming mode, deleting users, and resetting the AC-B31 to its factory default settings.

Programming Mode: The mode used when programming the AC-B32's system settings.

Proximity Cards: Electronically numbered ID badges allocated to

system users and read by the Proximity Card Reader.

R

Relay: An electronically controlled switch used for providing an Open Circuit or Closed Circuit output to external devices.

REX: An abbreviation of "Request To Exit".

Request To Exit (REX): Refers to a button which can release the door from inside. Commonly located at the reception desk, or near a door as an emergency door release.

S

Secondary Code: An additional code issued to enable access in Secured Mode. Users with non-identical Primary and Secondary Codes are Secure Users. Users with identical Primary and Secondary Codes are Master Users.

Secure Mode: The system setting (Mode of Operation) in which only valid Secure and Master Users have access upon presenting a valid code.

Secure User: A user which has a Primary Code and Secondary Code that are non-identical, and can gain access in any Mode of Operation.

Strike: See Lock Strike

T

Tamper Siren: The alert sound activated when a Back Tamper or Case Tamper event occurs. (Requires the BL-D40 External Sounder)

Tamper Siren Time: The time (user programmed) that the Tamper Siren will sound when activated.

Terminal Block: The rectangular connectors on the PCB used to attach wiring from external devices.

Technical Support

International Web Site:

<http://www.rosslare.com.hk/support/>

Asia, Australia, & South America:

Rosslare Enterprises Ltd.
905-912 Wing Fat Industrial Bldg.,
12 Wang Tai Road, Kowloon Bay,
Hong Kong.

Tel: (852) 2795 5630
Fax: (852) 2795 1508
E-mail: info@rosslare.com.hk

Europe, Russia, Middle East, Africa:

Rosslare Security Products S.r.l
Via F.lli Gabba 5, 20121 Milano, Italy

Tel: (39) 0382 24800
Fax: (39) 0382 24800
E-mail: marco.rogante@tin.it
rosslarect@aol.com

United States and Canada:

Rosslare NAPDC
200 East Howard Street, Suite 238,
Des Plaines, IL 60018
USA

Tel: (847) 827 6330
Fax: (847) 827 6433
E-mail: support@rosslare.net